

GENERAL REQUIREMENTS: (Residential Zones)

- For the purpose of these requirements and this handout the terms "wall" and "fence" are synonymous and are used interchangeably.
- Walls and fences exempt from building permits:** include masonry, concrete and walls of similar material less than 42" in height and other material (including hedges) not exceeding 6 feet in height provided they comply with all of the following:
 - The fence does not exceed 42" high in the front yard and complies to the openness requirements noted below;
 - The wall is not used as a retaining wall (walls retaining soil are limited to 36" from the bottom of the footing to the top of the wall).

Note: Fences meeting the above do not require a building permit, but may require an Encroachment Permit, License Agreement for construction within public right of way, or permission from owner of the easement (see note 6.)

3. Zoning Height Requirement:

- Front Yard** - 42" maximum height in required front yard setback, the first 18" may be solid the remaining 24" must be 50% open. See sheet 2 for samples of this. (Chain link fences are not permitted adjoining street.)
- Side and Rear Yards** - 7' height maximum allowed as measured from the grade of the enclosed lot.
- Side Yard of a Corner Lot** - 6' height maximum allowed as measured from the grade of the sidewalk or the grade of the street if there is no sidewalk.

Measurement of Height

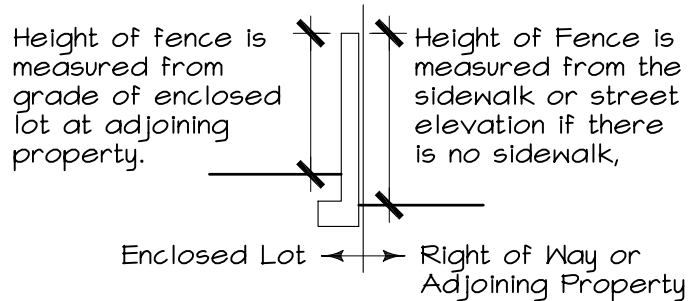

TYPICAL INTERIOR LOT

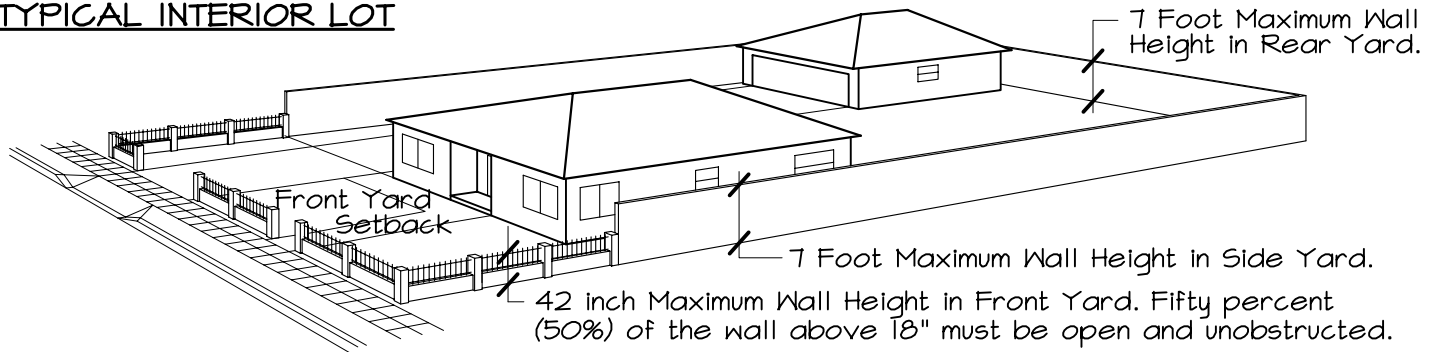

TYPICAL CORNER LOT

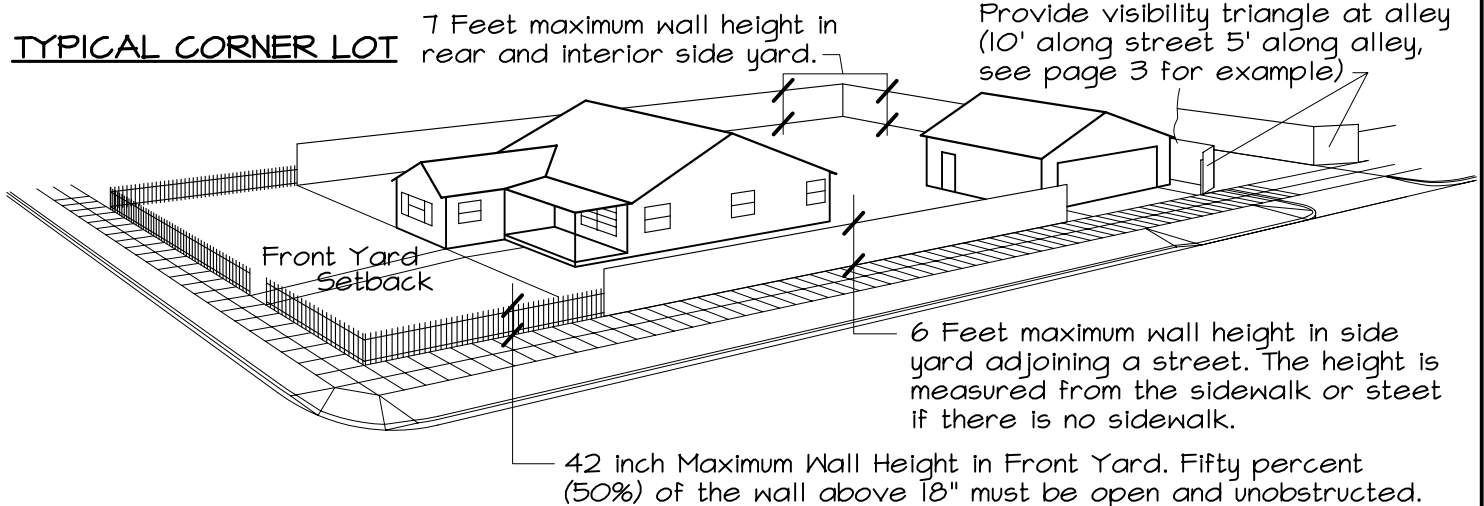

RESIDENTIAL WALL/FENCE REQUIREMENTS

HELP FOR THE HOMEOWNER
DEVELOPMENT SERVICES

Rob Roshanian 6/21/05
Building Official: Date

Date: 7/22/05 Sheet 1 of 5 B253

GENERAL REQUIREMENTS: (Residential Zones)

4. Front yard fence examples

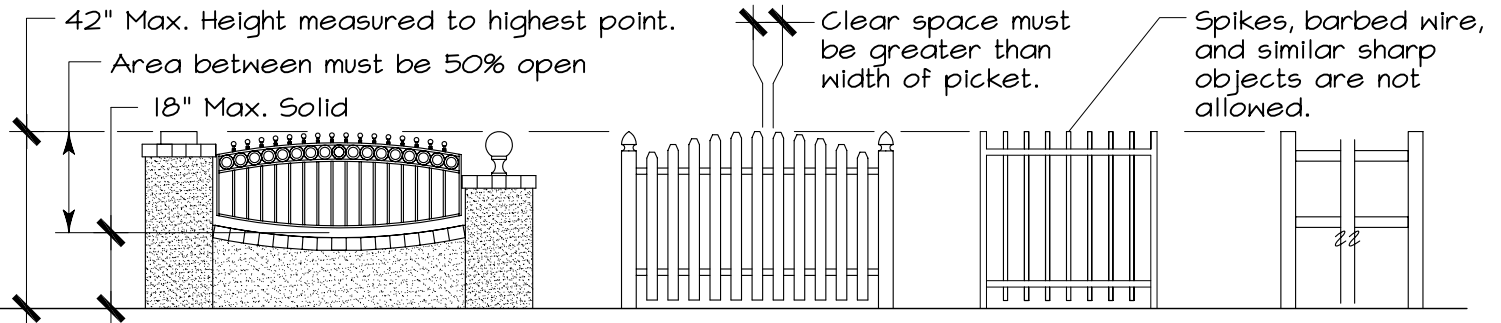

The highest point includes all projections, including but not limited to lights, ornamental attachments, etc...

5. Fences Shared Between Two Properties.

Walls that are to be constructed over property lines, where the wall will be shared between two neighbors requires a "Letter of Agreement" signed by all owners sharing the wall. See the attached form entitled "Letter of Agreement". This form must be completed and attached to the plan prior to plan submittal.

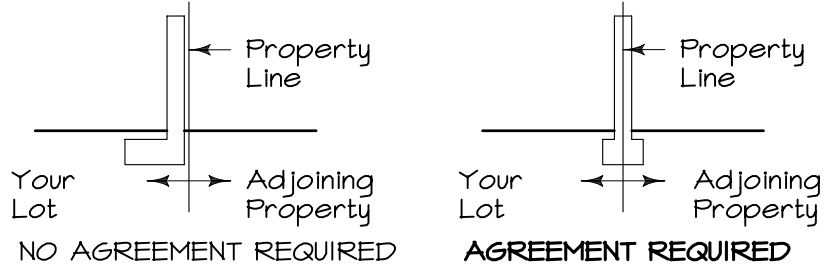

6. Fences Constructed within or near the Public Right of Way (ROW) or Easements:

- Fences within the City right of way (City Property) or within an easement must obtain an encroachment permit and Fence License Agreement regardless of height or material. These approvals may regulate locations, design, material and any other aspect of construction. Proposed encroachments on the city right of way or easement are reviewed, and if approved are issued by Development Services, and require recordation of the agreement.
- Work in easement must be approved by the easement holder.
- Verify location of Property Lines and Easements PRIOR to the start of construction, to ensure you are not encroaching on someone else's property, and prevent having to remove the work after construction. Water meters or other utilities are a good indication that there is an easement or property restriction in the area.
- Fence location must allow for a 5' sidewalk, 3' min. width at point restrictions, and clearances at water meters.

Gates and doors in fences shall not open over any public sidewalk, alley or street.

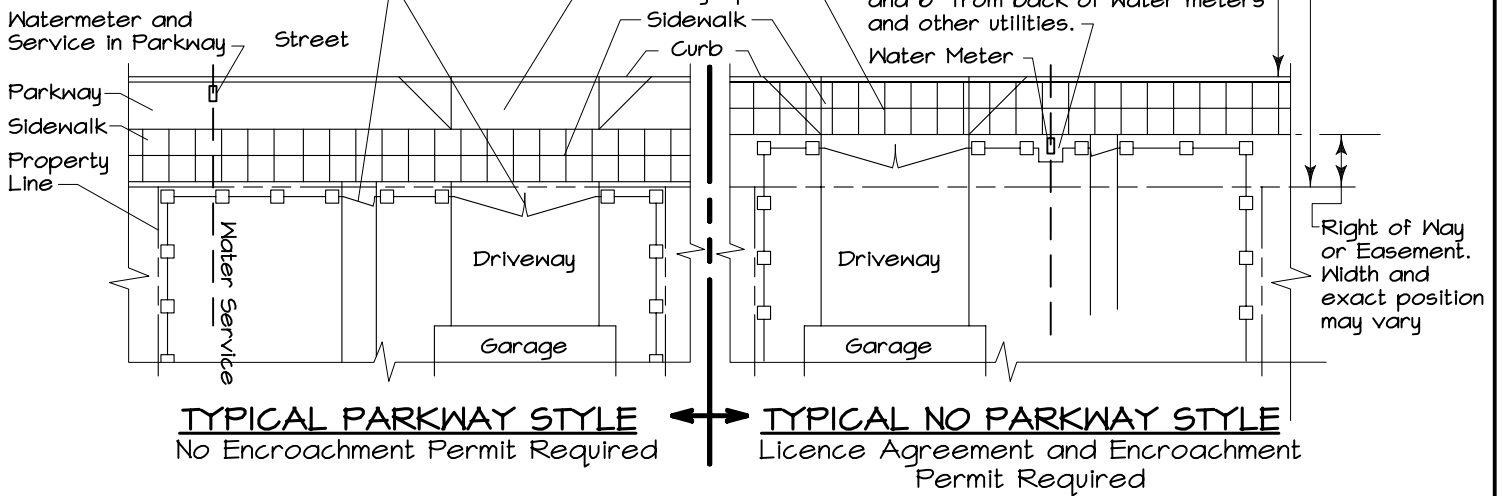

TYPICAL PARKWAY STYLE
No Encroachment Permit Required

TYPICAL NO PARKWAY STYLE
Licence Agreement and Encroachment Permit Required



PROPERTY WALL/FENCE REQUIREMENTS

HELP FOR THE HOMEOWNER
DEVELOPMENT SERVICES

Rob Roshanian 6/21/05
Building Official: _____ Date
Date: 6/21/05 Sheet 2 of 5 B253

c:\steve\handouts\253 property wall fence requirements.dwg

INSTRUCTIONS:

To aid in communication between yourself, the inspectors, and the plan checkers we have prepared this sample plot plan and construction section to aid you in the preparation of your plan for construction of a block wall/fence. Follow the instructions below and on sheet two and submit this information to the Development Services Counter.

On an 8-1/2"x11" sheet of paper show the following (although the plans is not required to be to scale, but should be close, 1/8" per foot will work for most residences.) The plans shall be legible and drawn in black ink. Provide a minimum of 1/2" border. Three complete sets of plans will be required for plan check. Each set of plans shall contain the following information:

1. Show the property size, configuration, street, and alley location;
2. Show all buildings and or structures on the property;
3. Show address where work is to be completed;
4. Show name and address of property owner;
5. Location of proposed wall/fence on parcel (lot);
6. Location and width of sidewalk and parkway where applicable;
7. Location of all public right of ways where applicable (street or alley.) This information may be obtained from the Development Services Counter.; and
8. Show if walls are to be constructed over property lines and shared with the adjoining property. A "Letter of agreement" between owners will be required.

For projects being proposed within a City utility easement or public right of way, the following additional information must be provided:

1. Detail Dimensions of the public Right of Way or Easement;
2. Show any water meters, power poles, fire hydrants, utility boxes, or any other objects located on or near the project;
3. Show curb ramps for accessibility or driveways;
4. Show sidewalk dimensions (3'-0" min. width at point restrictions) (required clearances for access ramps);
5. Wall placement and design shall allow for the placement of a future 5'-0" Sidewalk.
6. ATTACH COMPLETED FENCE LICENSE AGREEMENT to plan. (Document must be approved and recored prior to Permit.)
7. Be sure to provide the minimum 1/2" clear border or the County Recorder will not accept the plan.

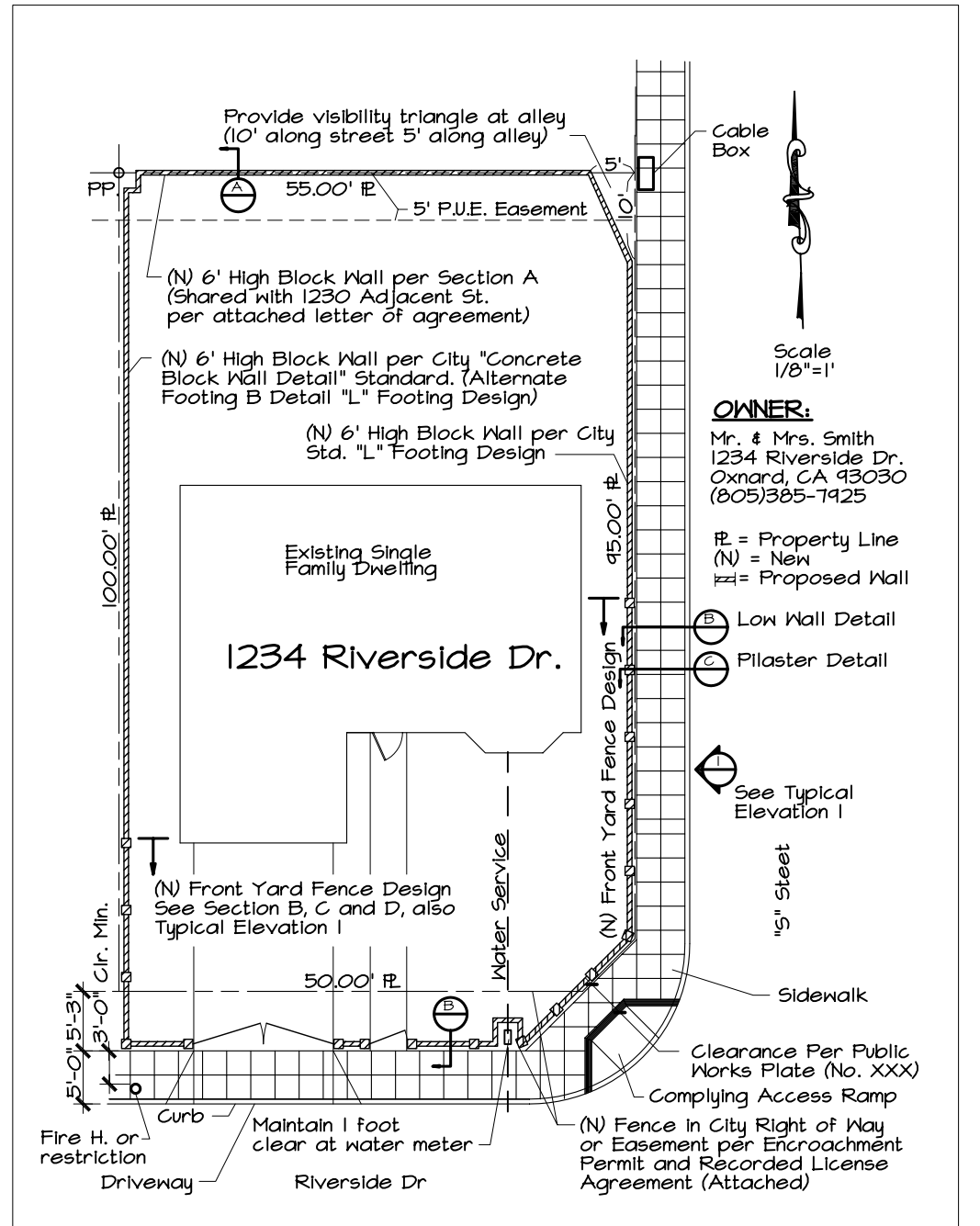

EXAMPLE PLANS FOR WALL/FENCES

HELP FOR THE HOMEOWNER
DEVELOPMENT SERVICES

Rob Roshanian 6/27/05
Building Official: Date
Date: 6/27/05 Sheet 3 of 5 B253

DRAWING THE CONSTRUCTION SECTION:

A construction section or detail provides clear instruction on how to construct your wall. Depending on the height and materials of construction your wall may require engineering. Wood walls over 6' and other walls over 42" require engineering. Engineering and a cross section are not required if the City's detail is used. For walls which do not follow the City standard the following information must be provided:

CONSTRUCTION SECTION OF WALL - (Use the City wall standard available at Development Services Counter or submit a design Wall by a Registered Civil Engineer or Licensed Architect.) Provide one section for each type of wall to be constructed, provide elevations of walls as required. Each wall section contain the following information:

- Scale
- Wall dimensions (height, length, etc...)
- Wall material to be used in construction. (i.e. wood, slumpstone block, wrought iron, steel, etc..)
- Fence/wall colors (provide manufacture's sections if available.)
- Typical grade change (if any between outside-inside of wall/fence and between adjacent property parcels.)
- Footing detail (show type, size, depth of footing and any steel reinforcement that may be required.)
- Size and spacing of all horizontal/vertical steel reinforcement.
- Size and spacing of all steel reinforcement for footing for wall.

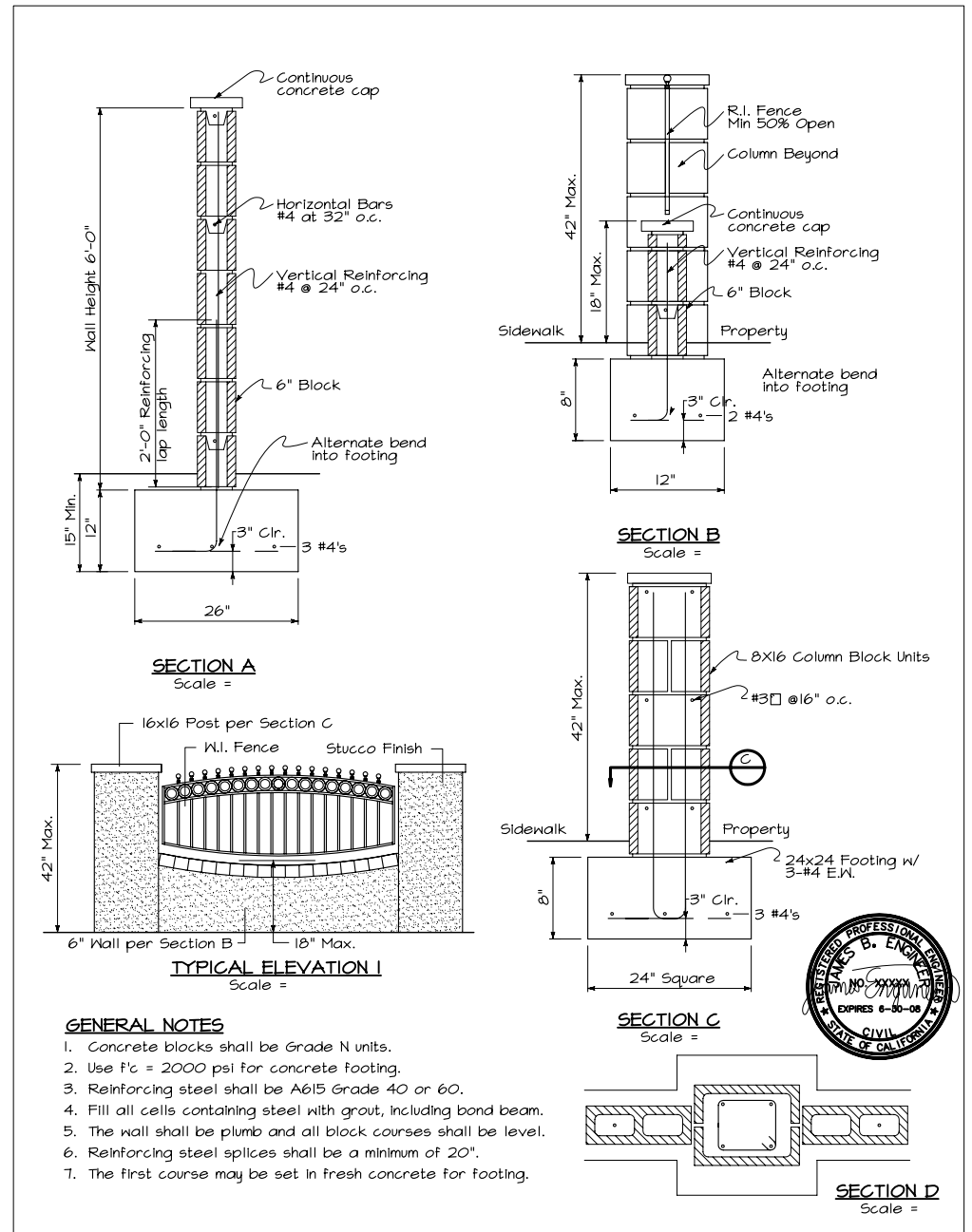

EXAMPLE PLANS FOR WALL/FENCES

HELP FOR THE HOMEOWNER
DEVELOPMENT SERVICES

Rob Roshanian 6/27/05
Building Official: Date
Date: 6/27/05 Sheet 4 of 5 B253



LETTER OF AGREEMENT

We, the undersigned, for ourselves, our assigns and successors in interest, do hereby agree to erect and maintain a fence, wall and/or block wall on our common property line.

PROPERTY LOCATED AT:

Address

Owner (Print)

Owner (Signature)

Date

PROPERTY LOCATED AT:

Address

Owner (Print)

Owner (Signature)

Date

This document must be notarized unless signed in the presence of a permit center staff.

Verified by: _____

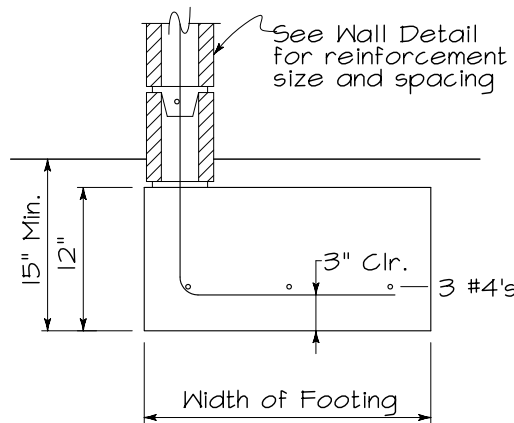
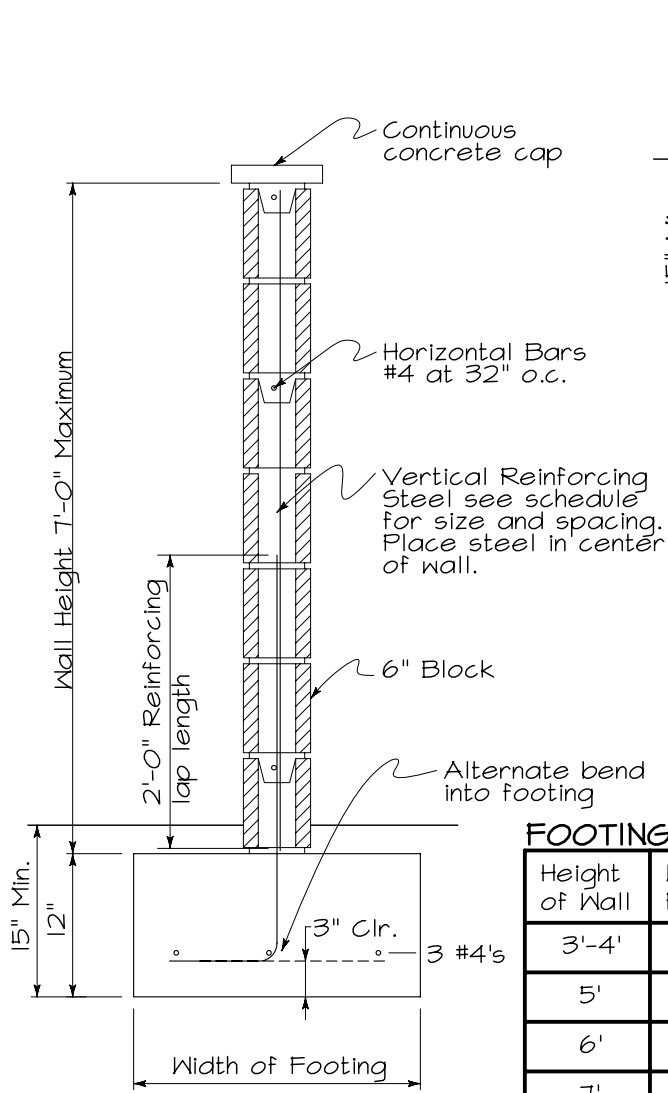

FOOTING B

| Height of Wall | Width of Footing |
|----------------|------------------|
| 3'-4' | 22" |
| 5' | 28" |
| 6' | 34" |
| 7' | 39" |

ALTERNATE FOOTING B

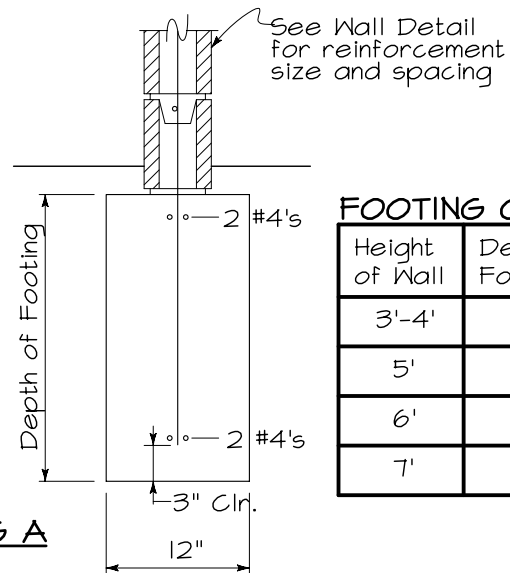

FOOTING C

| Height of Wall | Depth of Footing |
|----------------|------------------|
| 3'-4' | 24" |
| 5' | 28" |
| 6' | 32" |
| 7' | 36" |

FOOTING A

| Height of Wall | Width of Footing |
|----------------|------------------|
| 3'-4' | 18" |
| 5' | 22" |
| 6' | 26" |
| 7' | 30" |

MASONRY FENCE DETAIL & ALTERNATE FOOTING A

GENERAL NOTES

- Concrete blocks shall be Grade N units.
- Use $f'c = 2000$ psi for concrete footing.
- Reinforcing steel shall be A615 Grade 40 or 60.
- Fill all cells containing steel with grout, including bond beam.
- The wall shall be plumb and all block courses shall be level.
- Reinforcing steel splices shall be a minimum of 20".
- The first course may be set in fresh concrete for footing.
- No wall or fence shall be allowed within 36" of a fire hydrant and no wall, fence, or foundation shall be allowed within 12" of a water meter.
- Planning regulates the height, location, and design of the wall based on the zone, location on the property, and community design standards. Planning must approve the plans prior to any permit being issued.

ALTERNATE FOOTING C

REINFORCING STEEL TABLE

| Height of Wall | Vertical Steel |
|----------------|----------------|
| 5'-0" or less | #4 @ 32" o.c. |
| 7'-0" or less | #4 @ 24" o.c. |

NOTE: This wall is not designed to be used for a retaining wall



CONCRETE BLOCK WALL DETAIL

HELP FOR THE HOMEOWNER DEVELOPMENT SERVICES

Rob Roshanian 3/14/05
 Building Official: _____ Date: _____
 Date: 6/7/05 Sheet 1 of 1 B801